

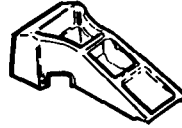

15

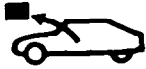

XM
856-1/1

1

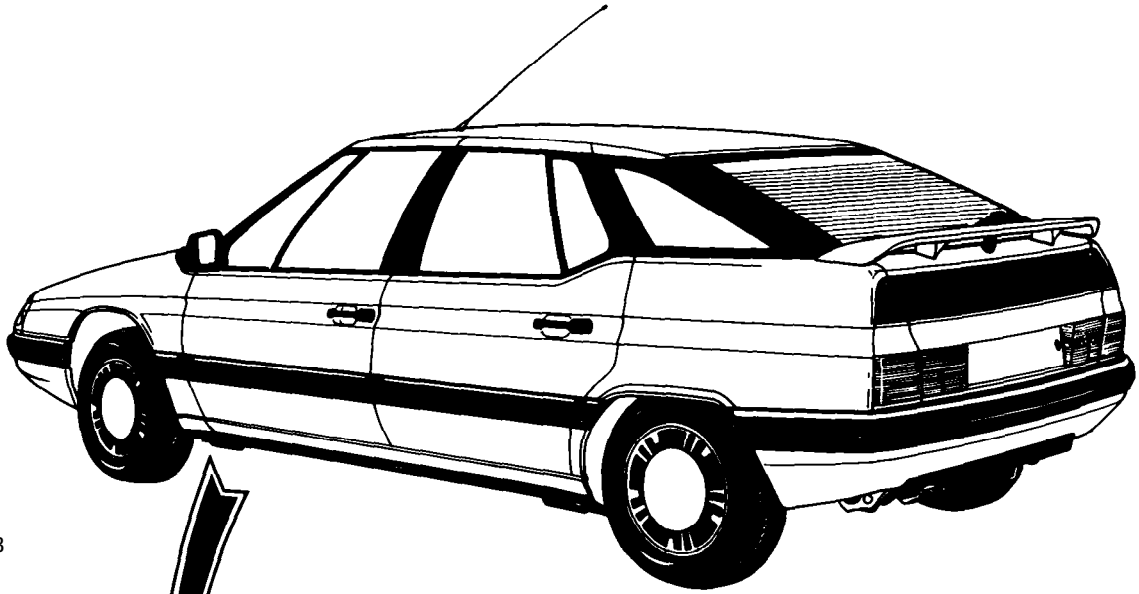

Y. 80-3

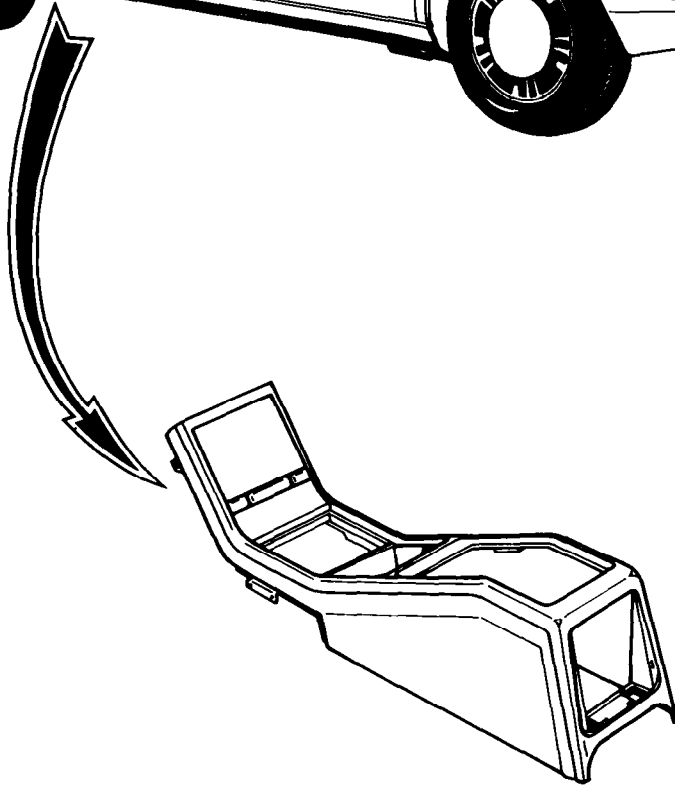

Y.80-28

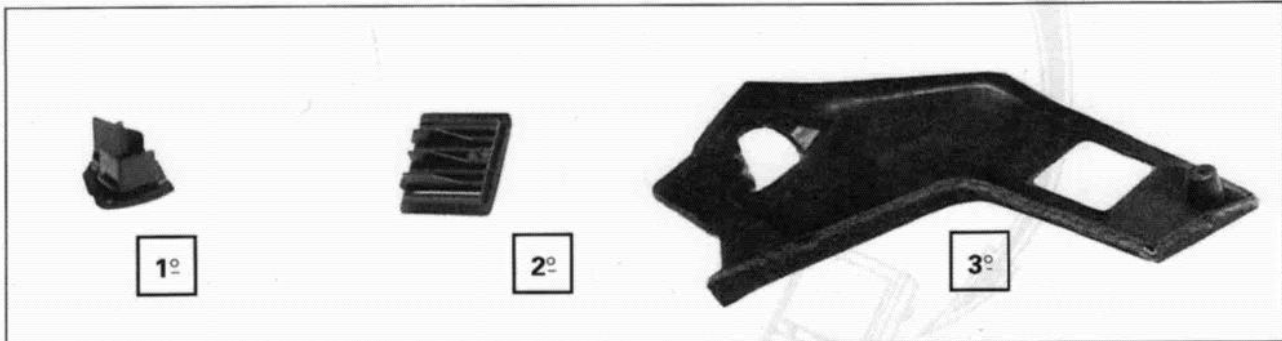
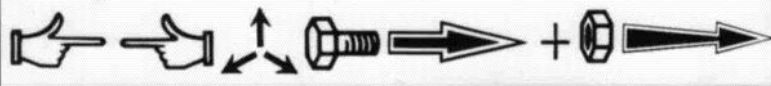
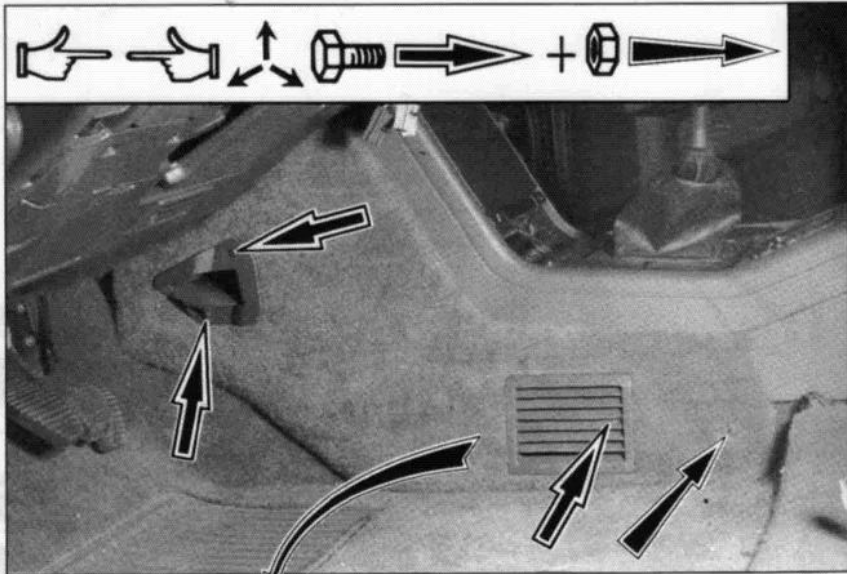
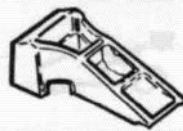

89-391

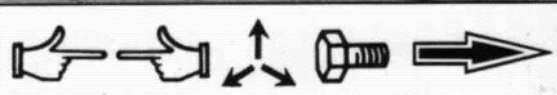
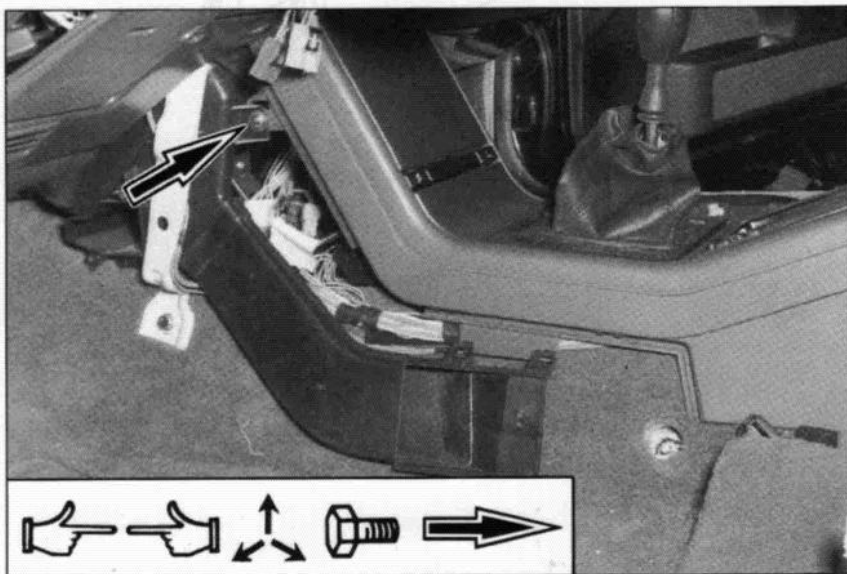



15

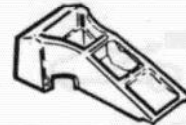
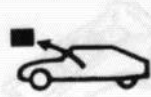

XM
856-1/1

3



1°

2°

3°

4°

5°

6°



1°

2°

3°

5°

6°



3°

5°

↔

↔

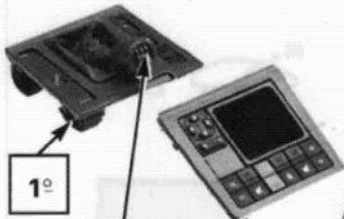

1°

2°

3°



4°



5°



6°

89-430

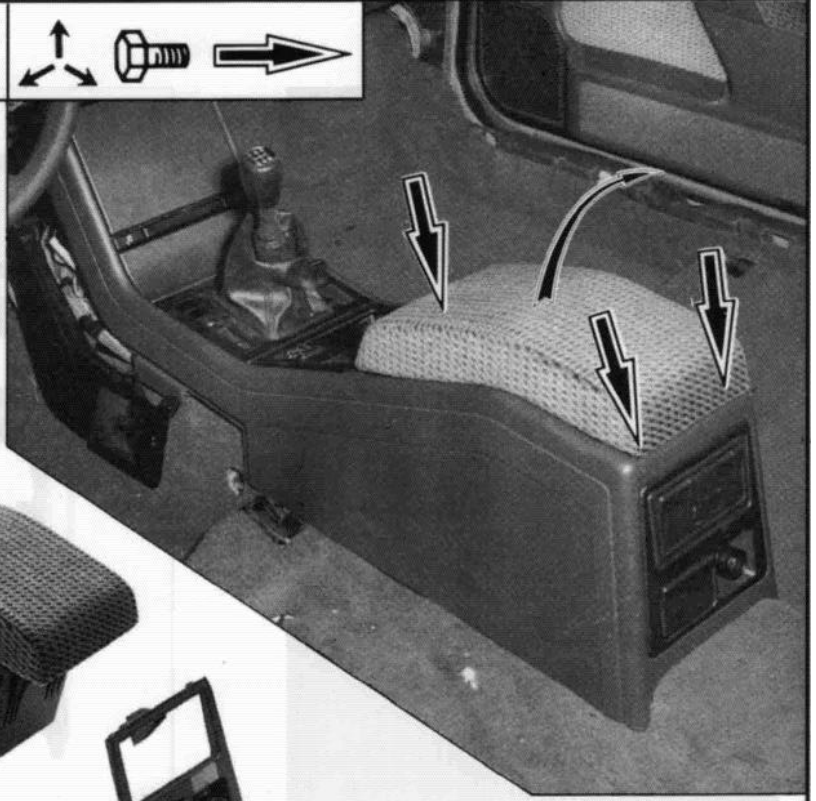

89-917

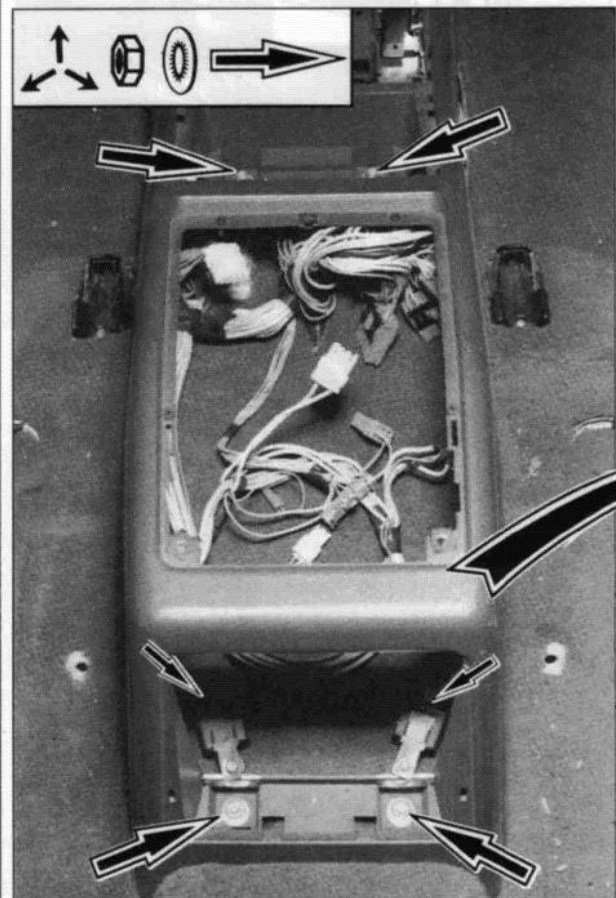

89-919

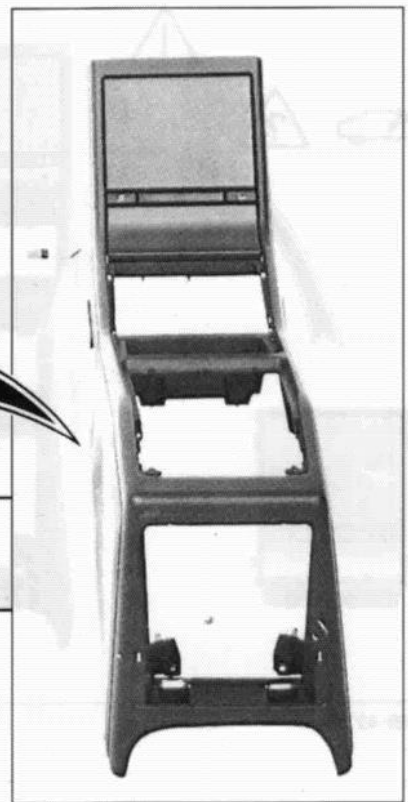

89-427

89-427 89-430 89-917 89-919

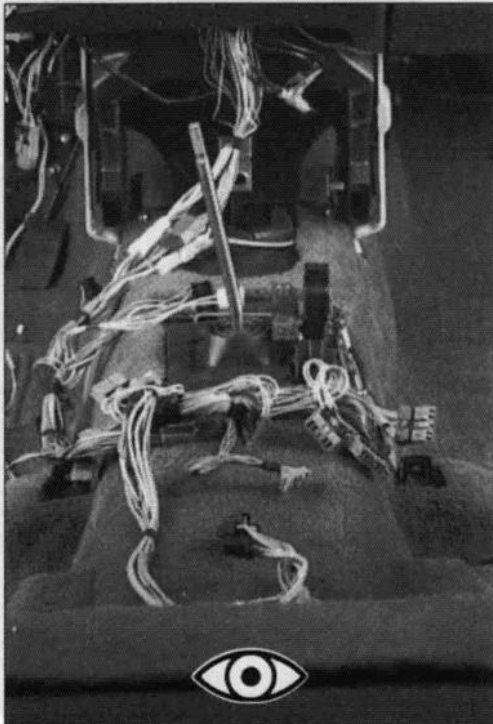
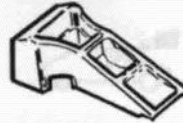
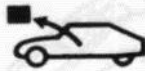

89-826

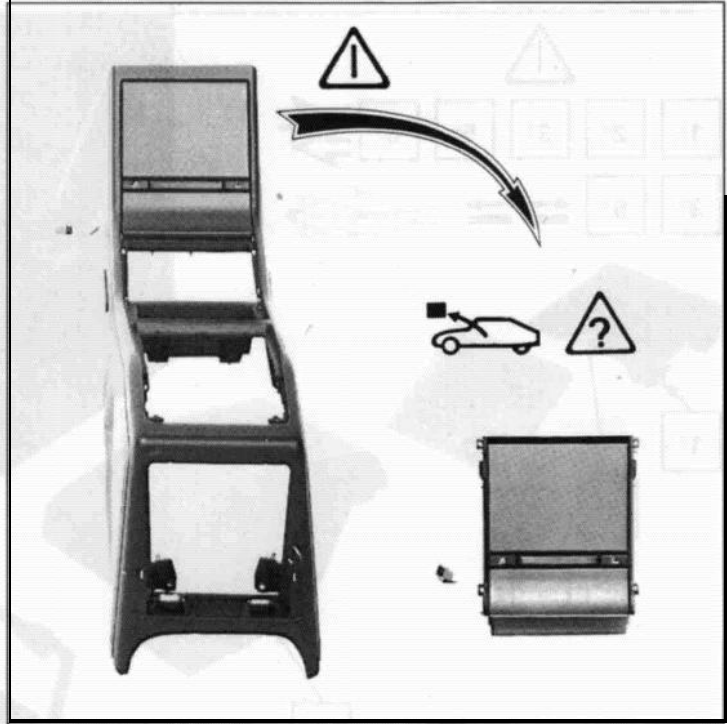

89-427 - 89-429

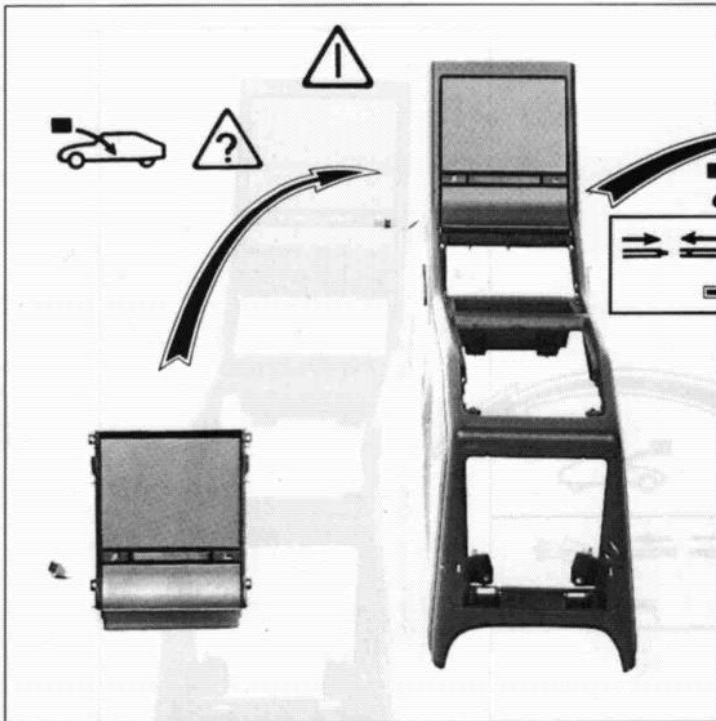

89-429 - 69-427

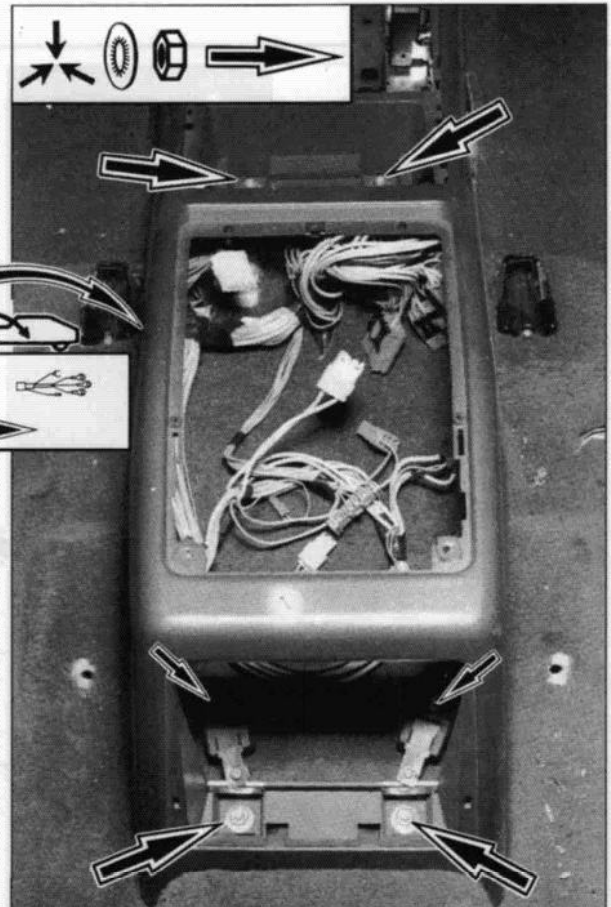

89-919



15

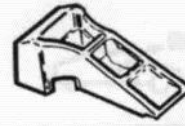
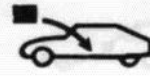
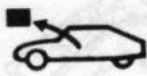

XM
856-1/1

5

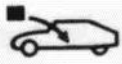

1°

2°

3°

4°

5°

6°



1°

2°

3°

5°

6°



3°

5°

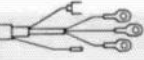

1°

2°

3°

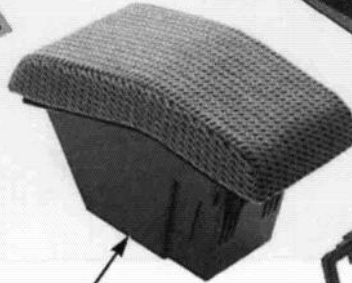

4°

5°

6°



89-430

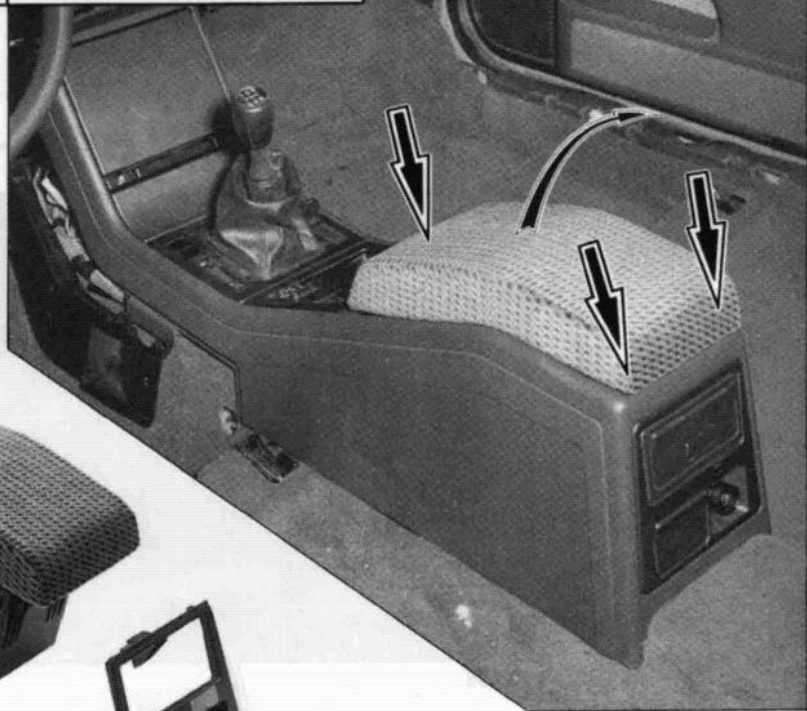

89-917

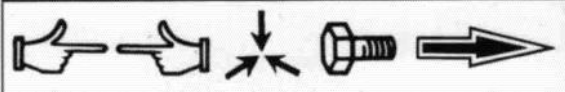
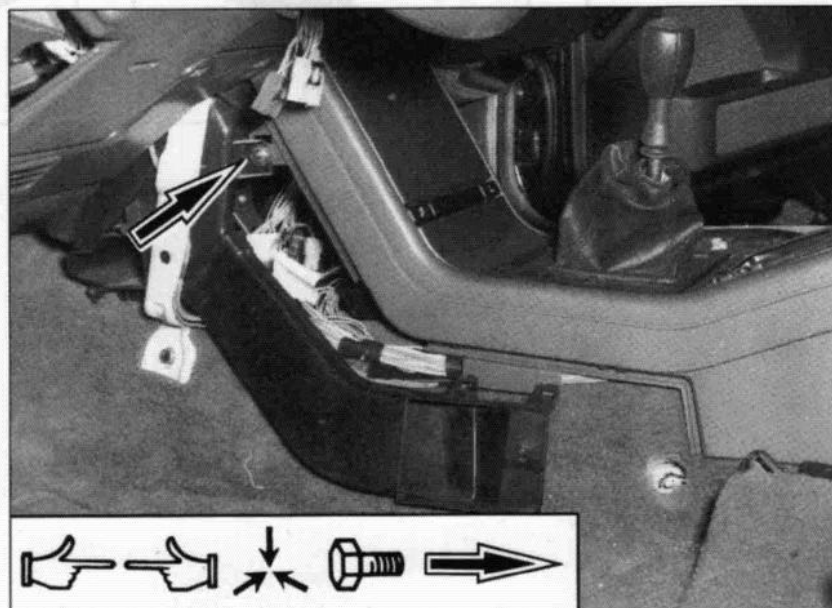

89-917

89-917 | 89-430 | 89-917

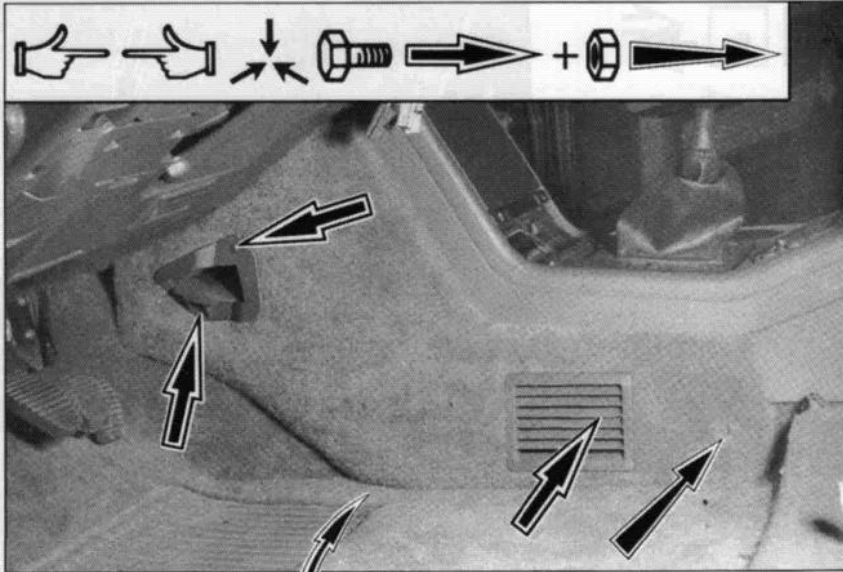
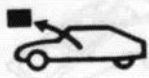

89-998

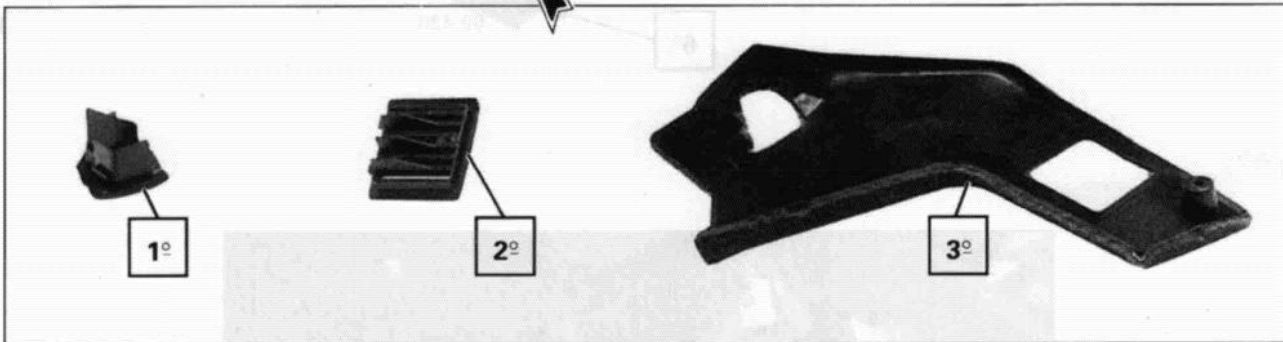

89-391